

## Microwave Movement Sensor (77898 only)

This product is fitted with a microwave movement sensor. Please see below detailed operating instructions.

### Technical Specifications:

Operating voltage	220 ~ 240V AC 50/60Hz	
Rated load	400W (Capacitive load) 800W (Resistive load)	
Stand-by power	≤ 0.5W	
Sensitivity	Ceiling mounted height: 3m	100% / 75% / 50% / 25% / 10%
	Ceiling mounted height: 6m*	100% / 75% / 50%
	Wall mounted height: 2m	100% / 75% / 50% / 25% / 10%
Hold-time	5s / 30s / 90s / 3min / 20min / 30min	
Daylight sensor	2Lux / 10Lux / 25Lux / 50Lux / Disable	
Microwave frequency	5.8 GHz ±75MHz	
Transmitting power	1mW Max.	
Detection range	Ceiling mounted height: 3m	3- 6m (radius )
	Wall mounted height: 1.5-2m	12-15m
Detection angle	360° (Ceiling) / 120° (Wall)	
Working temperature	-20°C ~ 60°C	

\*50%, 75%, 100% detection sensitivity is workable when installed at 6m mounting height. Only 10%, 25% sensitivity is not able to detect motion signal.

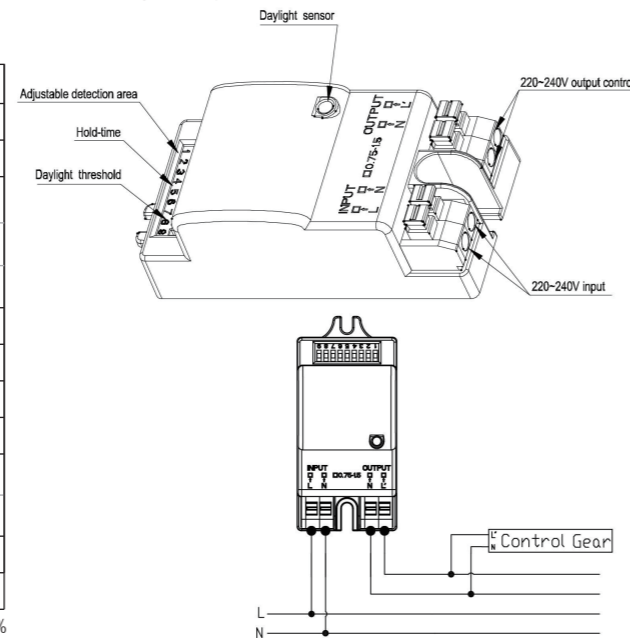

### Settings:

<p><b>1. Sensitivity</b></p> <p>Sensitivity can be adjusted by selecting the combination on the DIP switches for different applications.</p> <table border="1"> <tr> <td>I – 100%</td> <td>1</td> <td>2</td> <td>3</td> <td></td> </tr> <tr> <td>II – 75%</td> <td>I</td> <td>●</td> <td>●</td> <td>100%</td> </tr> <tr> <td>III – 50%</td> <td>II</td> <td>○</td> <td>●</td> <td>75%</td> </tr> <tr> <td>IV – 25%</td> <td>III</td> <td>●</td> <td>○</td> <td>50%</td> </tr> <tr> <td>V – 10%</td> <td>IV</td> <td>○</td> <td>○</td> <td>25%</td> </tr> <tr> <td></td> <td>V</td> <td>○</td> <td>○</td> <td>10%</td> </tr> </table>	I – 100%	1	2	3		II – 75%	I	●	●	100%	III – 50%	II	○	●	75%	IV – 25%	III	●	○	50%	V – 10%	IV	○	○	25%		V	○	○	10%	<p><b>2. Hold-time</b></p> <p>Hold-time refers to the time period that the light remains 100% on if no more movement is detected.</p> <table border="1"> <tr> <td>I – 5s</td> <td>4</td> <td>5</td> <td>6</td> <td></td> </tr> <tr> <td>II – 30s</td> <td>I</td> <td>●</td> <td>●</td> <td>5s</td> </tr> <tr> <td>III – 90s</td> <td>II</td> <td>○</td> <td>●</td> <td>30s</td> </tr> <tr> <td>IV – 3min</td> <td>III</td> <td>●</td> <td>○</td> <td>90s</td> </tr> <tr> <td>V – 20min</td> <td>IV</td> <td>○</td> <td>○</td> <td>3min</td> </tr> <tr> <td>VI – 30min</td> <td>V</td> <td>●</td> <td>●</td> <td>20min</td> </tr> <tr> <td></td> <td>VI</td> <td>○</td> <td>○</td> <td>30min</td> </tr> </table>	I – 5s	4	5	6		II – 30s	I	●	●	5s	III – 90s	II	○	●	30s	IV – 3min	III	●	○	90s	V – 20min	IV	○	○	3min	VI – 30min	V	●	●	20min		VI	○	○	30min	<p><b>3. Daylight sensor</b></p> <p>Different daylight threshold can be preset on DIP switches. Light will always turn on upon movement if daylight sensor is disabled.</p> <table border="1"> <tr> <td>I – 2Lux</td> <td>7</td> <td>8</td> <td>9</td> <td></td> </tr> <tr> <td>II – 10Lux</td> <td>I</td> <td>●</td> <td>●</td> <td>2Lux</td> </tr> <tr> <td>III – 25Lux</td> <td>II</td> <td>●</td> <td>○</td> <td>10Lux</td> </tr> <tr> <td>IV – 50Lux</td> <td>III</td> <td>○</td> <td>○</td> <td>25Lux</td> </tr> <tr> <td>V – Disable</td> <td>IV</td> <td>●</td> <td>○</td> <td>50Lux</td> </tr> <tr> <td></td> <td>V</td> <td>○</td> <td>○</td> <td>Disable*</td> </tr> </table> <p>*Disable means the daylight sensor does not work. The sensor will turn on light once motion is detected regardless of ambient light level.</p>	I – 2Lux	7	8	9		II – 10Lux	I	●	●	2Lux	III – 25Lux	II	●	○	10Lux	IV – 50Lux	III	○	○	25Lux	V – Disable	IV	●	○	50Lux		V	○	○	Disable*
I – 100%	1	2	3																																																																																														
II – 75%	I	●	●	100%																																																																																													
III – 50%	II	○	●	75%																																																																																													
IV – 25%	III	●	○	50%																																																																																													
V – 10%	IV	○	○	25%																																																																																													
	V	○	○	10%																																																																																													
I – 5s	4	5	6																																																																																														
II – 30s	I	●	●	5s																																																																																													
III – 90s	II	○	●	30s																																																																																													
IV – 3min	III	●	○	90s																																																																																													
V – 20min	IV	○	○	3min																																																																																													
VI – 30min	V	●	●	20min																																																																																													
	VI	○	○	30min																																																																																													
I – 2Lux	7	8	9																																																																																														
II – 10Lux	I	●	●	2Lux																																																																																													
III – 25Lux	II	●	○	10Lux																																																																																													
IV – 50Lux	III	○	○	25Lux																																																																																													
V – Disable	IV	●	○	50Lux																																																																																													
	V	○	○	Disable*																																																																																													

### Trouble shooting:

Malfunction	Cause	Remedy
The light will not come on	Incorrect light-control setting selected	Adjust daylight threshold setting
	Faulty lamp	Replace lamp
	No power supply	Check power to sensor
The lamp is always on	Continuous movement in the detection zone	Check detection area setting
The lamp is on without any identifiable movement	The sensor is not mounted for reliably detecting movement	Securely mount enclosure
	Movement occurred, but not identified by the sensor (Movement behind wall, movement of small object in immediate lamp vicinity etc.)	1. Reduce sensitivity. 2. Check the movement behind walls to avoid facilities such as water pipe, fan, which may mis-trigger the sensor.
The lamp will not work despite movement	Rapid movements are being suppressed to minimize malfunctioning or the detection radius is too small.	Check detection area setting

For further information, please visit <https://www.lighting-info.co.uk/77897>

V5 12/12/2022  
**UK Manufacturer:** BH17 7BY  
**EU Manufacturer:** Brilliant AG,  
 Brilliantstrasse 1, D-27442 Gnarrenburg

saxby  
lighting

Instruction manual

# Forca CCT LED Bulkhead

77897, 77898



www.saxbylighting.com

saxby  
lighting

Thank you for purchasing this light fitting. Please read the instructions carefully before use to ensure safe and satisfactory operation of this product. Please retain these instructions for future reference.

## Warning

 This power supply is Double Insulated and does not require connection to an Earth circuit.

Please read these instructions carefully before commencing any work.

This unit must be fitted by a competent and qualified electrician. Install in accordance with IEE Wiring regulations and current Building Regulations.

To prevent electrocution switch off at mains supply before installing or maintaining this fitting. Ensure other persons cannot restore the electrical supply without your knowledge. If you are in any doubt, please consult a qualified electrician.

This light fitting should be connected to a circuit with a 30mA RCD fitted.

If replacing an existing fitting, make a careful note of the connections.

This product contains non-replaceable parts and cannot be serviced. If damage occurs the part should be scrapped.

Waste electrical products should not be disposed of with household waste. Please recycle where facilities exist. Check with your local authority or retailer for recycling advice.

## Layout

Plan the desired layout of these fittings carefully, ensuring the cables will reach the distance between the junction box and the light fitting.

Avoid locating any cables in positions that would cause a hazard. Position cables and outdoor rated junction boxes (not supplied) away from areas where they may be at risk from being cut, trapped or damaged.

We recommend that you use H05RN-F specification cable (not supplied) which is an outdoor grade, rubber sheathed cable.

The mains supply cable must have a minimum cross sectional area of 1.0mm<sup>2</sup>

Cables must be protected using suitable conduit or plastic trunking.

The products can be wall or ceiling mounted. If wall mounting ensure that the power supply is at the bottom.

## Individual casings

The following individual casings are available for purchase separately.

77904 : White plain	77907 : Grey plain	77910 : Black plain
77905 : White eyelid	77908 : Grey eyelid	77911 : Black eyelid
77906 : White grill	77909 : Grey grill	77912 : Black grill
		77913 : Chrome plain

## Installation

Existing fittings must be completely removed before installation of a new product. Before removing the existing fitting, **carefully note the position of each set of wires.**

Note that the switch is turned off before installation.

Ensure that the screws and cable entry points are sealed to maintain the IP rating of the product.

- Remove the 4 fixing screws and detach the shade. Keep safe for refitting later.
- Hold the product in place and mark the position of the holes. Ensure the wall is capable of holding the weight of the product, or if fitting to a ceiling, ensure there is a joist at the point of fixing to support the weight of the product.
- Knock out the chosen fixing holes.
- Fix into position. Take care to avoid damaging any concealed wiring and pipes. The correct fixings should be used for brick, cavity walls or plasterboard.
- Pierce a hole in the grommet, and pull the cable through.
- Wire as detailed wiring diagram.
- Ensure that the screws and cable entry points are sealed to maintain the IP rating of the product.
- Refit the shade, ensuring that the seals are correctly located.
- Gently push your chosen casing onto the shade until it clips in place.
- Replace fuse or circuit breaker and switch on. Your light is now ready for use.

## Wiring

- This product is double insulated and must not be earthed. If there are any incoming earth cables, they must be joined together and well insulated with good quality insulation tape. This is to ensure earth continuity throughout your property.
- Having correctly identified the wiring from your existing light fitting, connect to the quick fit connection block in the following way, using the supplied link cables where necessary.

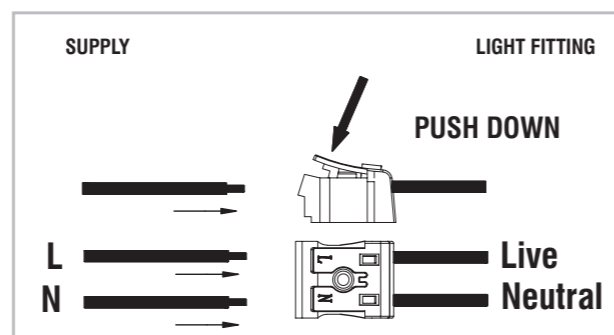



## Check that...

- You have correctly identified the wires.
- The connections are tight.
- No loose strands have been left out of the connection block.

## CCT Function

This product is colour changing and can be either warm white (**3000K**) or cool white (**4000K**) or daylight white (**6500K**). Choose your preferred colour before installing by using the CCT switch inside the product.

<b>A</b>	<b>WARM WHITE</b>	<b>3000K</b>			
<b>B</b>	<b>COOL WHITE</b>	<b>4000K</b>			
<b>C</b>	<b>DAYLIGHT WHITE</b>	<b>6500K</b>			

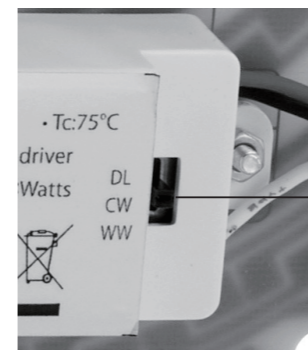

CCT switch

## Technical data

Supply Voltage: 220-240 V~, 50 Hz

Bulb Type: 18W LED module (SMD), CCT 3000/4000/6500K  
This product contains a light source of energy efficiency class **E**.

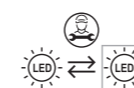

Replaceable (LED only) light source by a professional



Replaceable control gear by a professional



Conformity with all relevant UKCA Directive requirements.



Conformity with all relevant EC Directive requirements.



The power supply is Double Insulated and does not require connection to an Earth circuit.



Waste electrical products should not be disposed of with household waste. Please recycle where facilities exist. Check with your Local Authority or local store for recycling advice.



This product is not suitable for dimming.



This product is rated at IP65.

## Care and Safety

We recommend cleaning with a soft dry cloth. Do not use solvents or abrasive cleaners as these could damage the finish. For your safety, always switch off the power supply before cleaning.

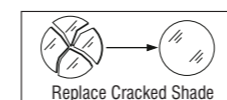

This light source is protected by a shade. This part must be replaced immediately should the shade become cracked or damaged. This fitting must not be used without the shade in place.